



RAVEK

CAN-AM MAVERICK X3 2017-2023

MOLLE STORAGE PANELS



INSTRUCTION MANUAL



RAVEK

CAN-AM MAVERICK X3 2017-2023

MOLLE STORAGE PANELS

Part #: 65-301

Fitment: CAN-AM MAVERICK X3 2017-2023

PARTS INCLUDED:

- LEFT MOLLE PANEL (1X)
- RIGHT MOLLE PANEL (1X)
- CLAMP (10X)
- M6 X 30MM SPACER (4X)
- M6 X 1MM NYLON NUT (10X)
- M6 X 1MM X 50MM ALLEN SCREW (4X)
- M6 X 1MM X 30MM TORX SCREW (4X)
- M6 FLAT WASHER (4X)
- M6 FENDER WASHER (6X)
- M6 X 45MM SPACER (2X)
- M6 X 1MM X 60MM ALLEN SCREW (2X)

TOOLS NEEDED:



10mm Wrench



Ratchet



10mm Drive Deep Socket

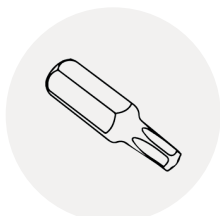

T-40 Torx



4mm Allen Wrench

**DON'T LIKE INSTRUCTIONS?
VISIT OUR WEBSITE TO ACCESS
THE VIDEO TUTORIAL**



1

LOCATE THE REAR ROLL CAGE

To begin, locate the rear roll cage area where the MOLLE panels will be mounted; use the image above as a guide. [SEE FIGURE 1A]

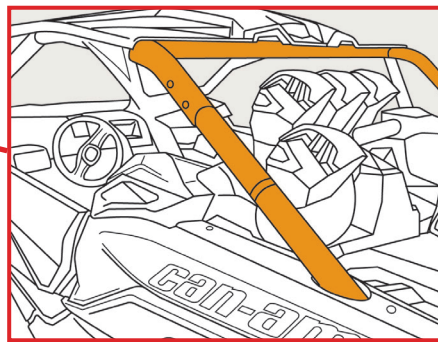
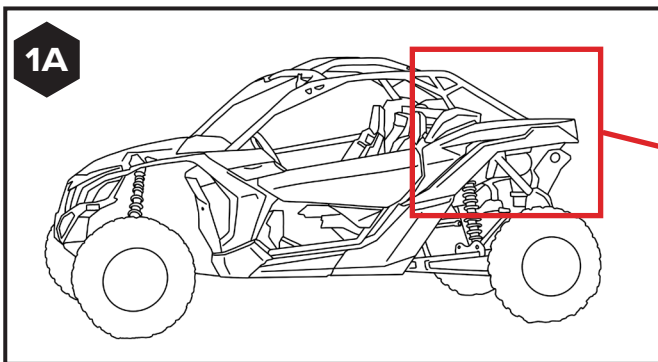

2

REMOVE OEM SCREWS

On the left side of the Maverick, find the screws shown in figure 2A, remove these screws using a T-30 Torx. [SEE FIGURE 2A]

After removing the screw, find the plastic insert where the screw was threaded. Reach underneath the body panels and push the insert out while squeezing its sides. [SEE FIGURE 2B]

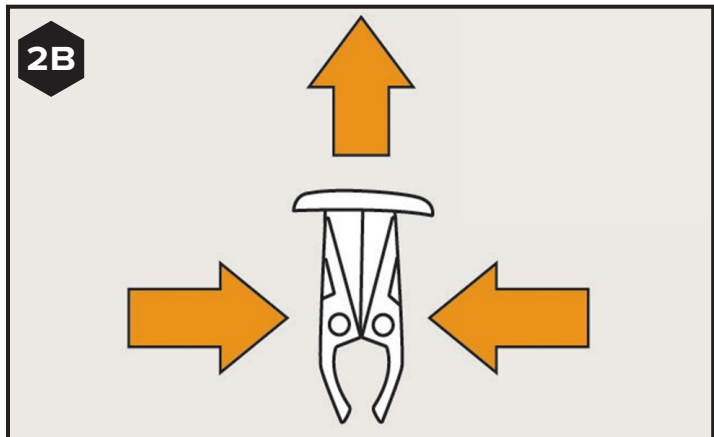
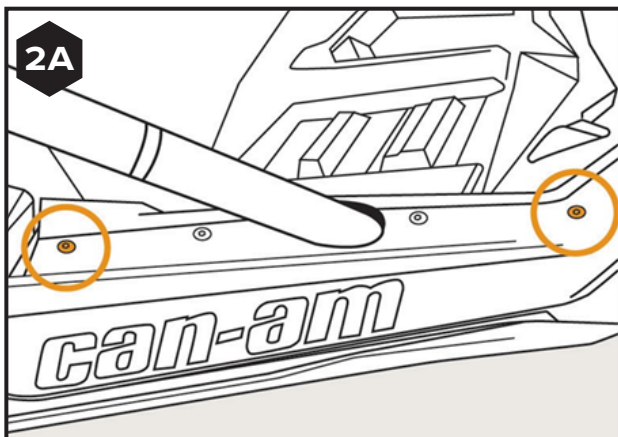

3

INSTALL THE LEFT SIDE PANEL

- Insert the M6 x 1mm x 60mm Allen screw through the hole on the MOLLE Storage panel and the roll cage. [SEE FIGURES 3A & 3B]
- Place the M6 x 45mm Spacer between the MOLLE Storage Panel and the roll cage. [SEE FIGURE 3C]

Finger-tighten a nut onto the end of the screw behind the roll cage. [SEE FIGURE 3D]

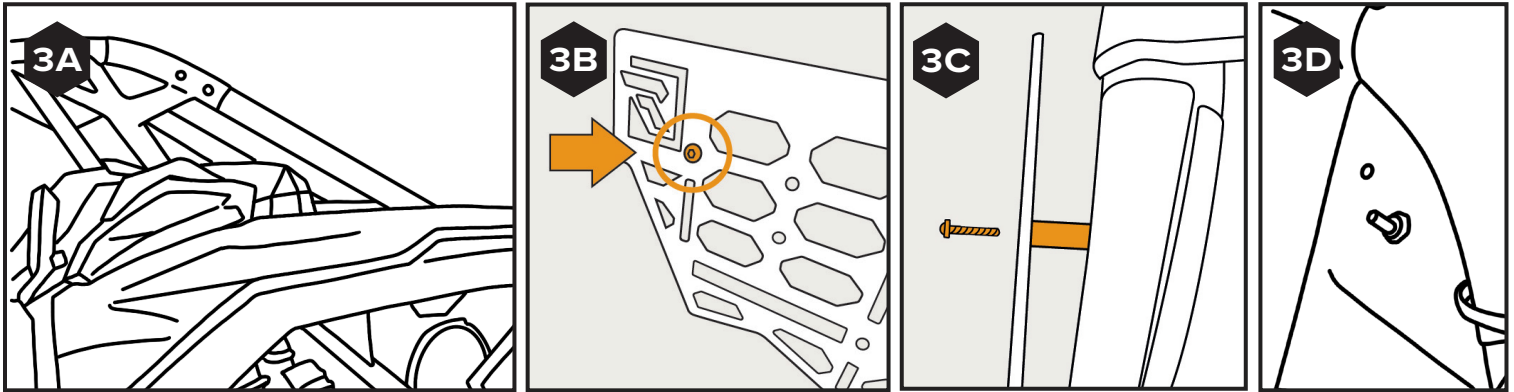

4

SECURE TABS

- Use two M6 x 1mm x 30mm Torx Screws, two M6 flat washers, two M6 fender washers, and two nuts.
- Using the hardware previously mentioned, secure the tabs to the body of the Maverick and finger-tighten the nuts. [SEE FIGURE 4A]

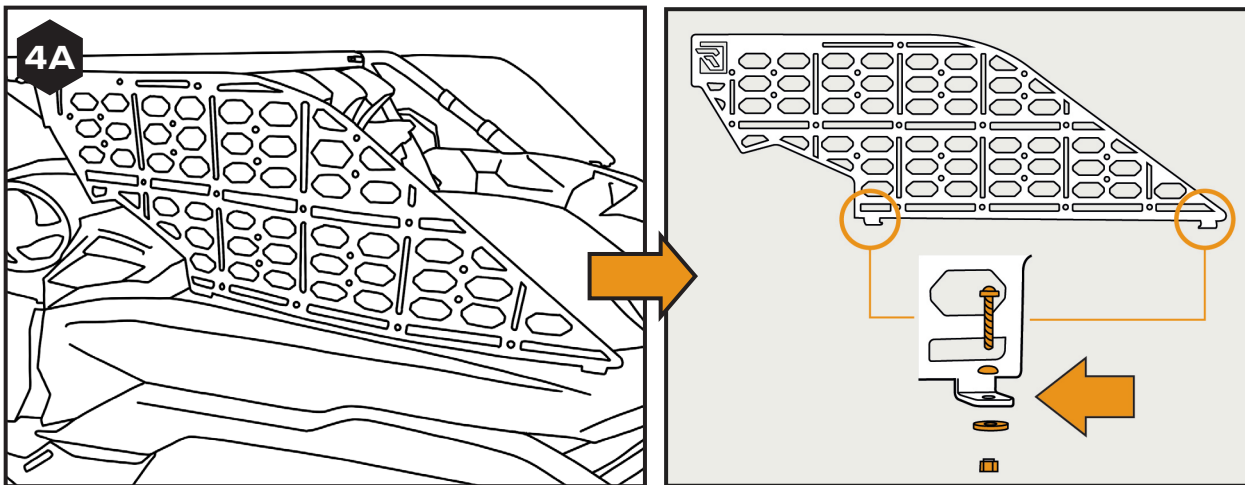

5

LOCATE CLAMPS

Locate the clamps in your kit and identify the flat side of each clamp. This side will rest flat against the back of the MOLLE Storage Panel when you attach it to the roll bar.

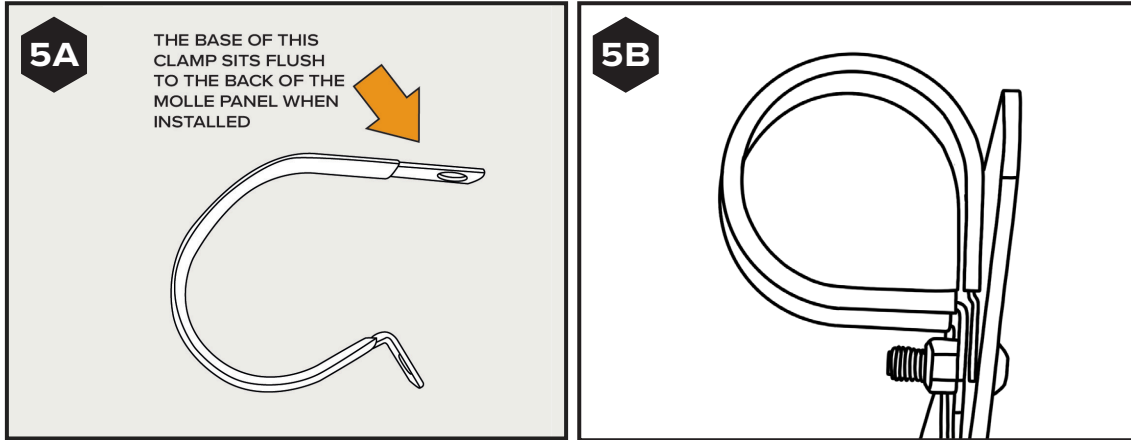

6

INSTALL MOLLE CLAMP

Place the clamp on the underside of the roll bar, with the flat side facing the back of the MOLLE Panel.

Use one of the M6 x 1mm x 50mm Allen Screws provided. Insert the screw through the circled hole on the MOLLE Panel, the M6 x 30mm Spacer (the smaller spacer), and the holes on the clamp. [SEE FIGURE 6A – 6C]

Once the screw is through all the holes, thread a nut onto the back side of the screw. Tighten it slightly with your fingers.

NOTE: It might be difficult to align the clamp with the hole on the MOLLE Panel while inserting the screw. Consider asking a friend to help you with this step.

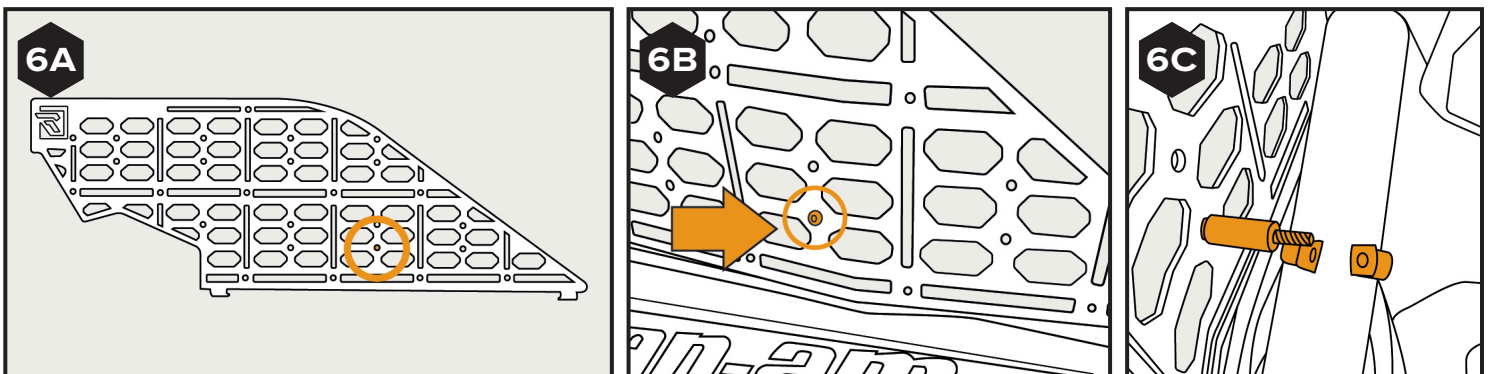

7

INSTALL 2ND MOLLE CLAMP

Use one more MOLLE Clamp, an M6 flat washer, an M6 x 1mm x 50mm Allen Screw, an M6 x 30mm Spacer, and a nut and place the clamp in the slot indicated in orange.

Secure the clamp to the roll bar using the hardware mentioned above and tighten the nut slightly with your fingers.

NOTE: The MOLLE Panels can be used on Mavericks with or without accessories in the roll cage. However, the mounting locations might vary depending on your accessories. If the suggested holes don't work, try using other holes or slots to securely attach the MOLLE Panel to your Maverick.

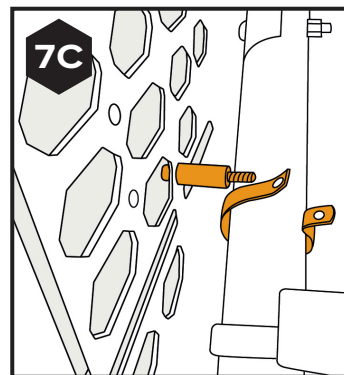
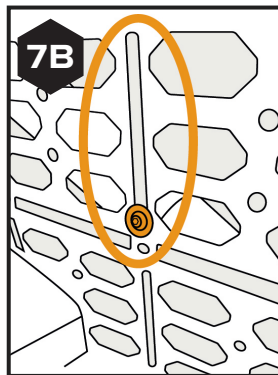
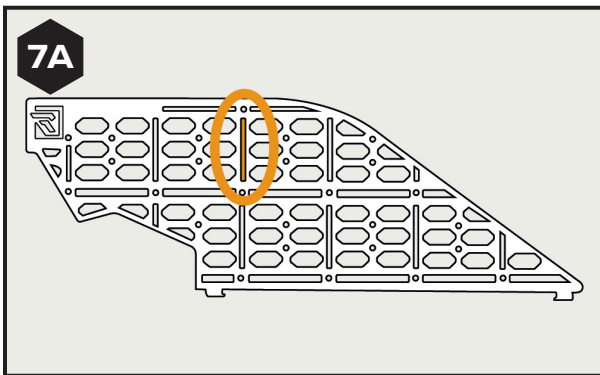

8

TIGHTEN HARDWARE

Use a ratchet and a 10mm deep well socket to tighten the hardware installed in step 4.

Use the same tools to tighten the hardware at the other mounting locations. [SEE FIGURES 8A & 8B]

NOTE: Be careful not to overtighten the hardware, as this could damage the plastic fender panel.

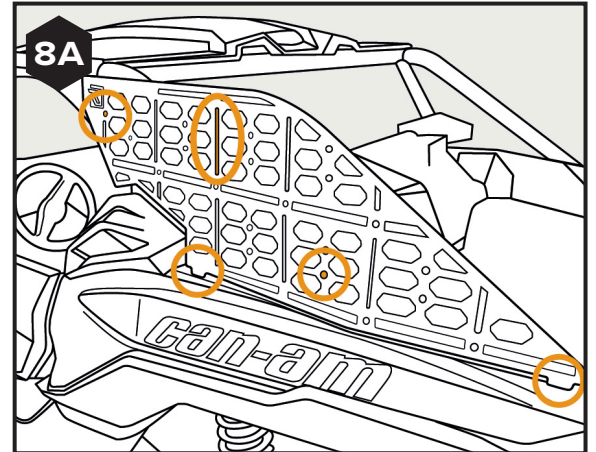

9

REPEAT STEPS 2 - 8

Repeat steps 2-8 on the right side of the UTV to mount your MOLLE Storage Panels securely to the roll cage of your Maverick.

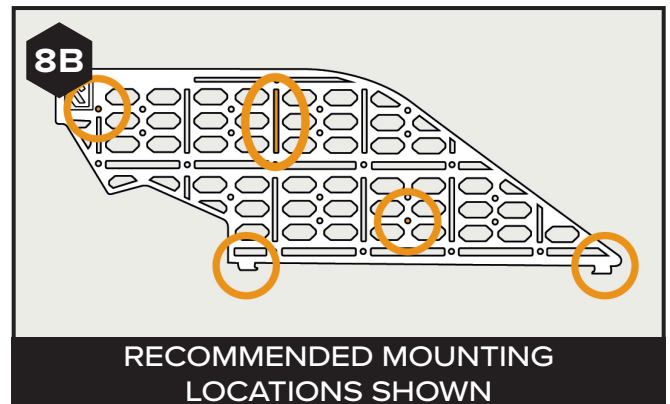



RAVEK

BUILT FOR MORE

WHY RAVEK

Stock UTVs don't come with enough storage, lighting, comfort, and protection. That's why we started RAVEK.

We live to design, manufacture, and test innovative SxS upgrades that elevate the riding experience. Here's what you can expect from us:

- Durable products built to last (100% lifetime guarantee)
- UTV upgrades thoughtfully designed & tested by riders
- Outstanding installation support (videos & USA customer service)
- Constant flow of epic riding content (check out our social media)

We're confident your RAVEK product will earn its place on your machine. Please call or e-mail us if we can help.

- Harry & Ricky (Brothers & Owners)

MESSAGE FROM THE DESIGNER

The CAN-AM Maverick looks angry, its more striking than most other UTVs in just its angularity and aggressive stance.

This poses a continuous challenge for products designed for it as it should match that angular design language. I feel the Maverick MOLLE Panel really adds to the Maverick's design aesthetic, creating wings that extend from the body, adding both form and function to a UTV that typically prioritizes driving over storage and utility.



RAVEK
BUILT FOR MORE